

DATA SHEET

Company		Date	31/01/2023
Project		Item	
		Ref No.	

ECO SNM 80-400

Horizontal, single stage, radially split, closed-coupled, volute casing type conforming to EN 733 and EU 547/2012

Operating Point Data

Capacity	:	Power at Duty Point	:
Head	:	Frequency	: 50 Hz
Efficiency (%)	:	Voltage	: 400 V
Impeller Diameter	: 424 mm	Motor Power	: 45.00 kW
NPSHr	:	Nominal Speed	: 1470 rpm
Shut Off Head	: 62.4 m		

Liquid Data

Liquid	: Water	Density	: 998.30 kg/m ³
Temperature	: 20 °C	Viscosity	: 1.005 cSt

Pump Data

Design	: Single Stage, End Suction, Monoblock		
Installation	: Horizontal	Direction Of Rotation	: Clockwise from the drive end
Suction Flange	: EN 1092 PN 16-DN 100	Impeller Type	: Radial impeller
Discharge Flange	: EN 1092 PN 16-DN 80	Type of Shaft Sealing	: Mechanical Seal
Pressure rating	: PN10		

Minimum Efficiency Index (MEI) >= 0,4

Materials

Volute Casing	0.6025 / GG25 / EN-GJL-250 / ASTM A48 Class 40B
Casing Cover	0.6025 / GG25 / EN-GJL-250 / ASTM A48 Class 40B
Impeller	0.6025 / GG25 / EN-GJL-250 / ASTM A48 Class 40B
Shaft	1.4021 / X20Cr13 / ASTM A276 Type 420
Mechanical Seal Sleeve	1.4021 / X20Cr13 / ASTM A276 Type 420
Motor Pedestal	0.6025 / GG25 / EN-GJL-250 / ASTM A48 Class 40B

Operating Point Data

Company		Date	31/01/2023
Project		Item	
		Ref No.	

ECO SNM 80-400

Horizontal, single stage, radially split, closed-coupled, volute casing type conforming to EN 733 and EU 547/2012

Capacity:		NPSHr:	
Head:		Motor Power:	45.00 kW
Efficiency (%):		Nominal Speed:	1470 rpm
Power at Duty Point:		Frequency:	50 Hz
Viscosity:	1.005 cSt	Density:	998.30 kg/m ³

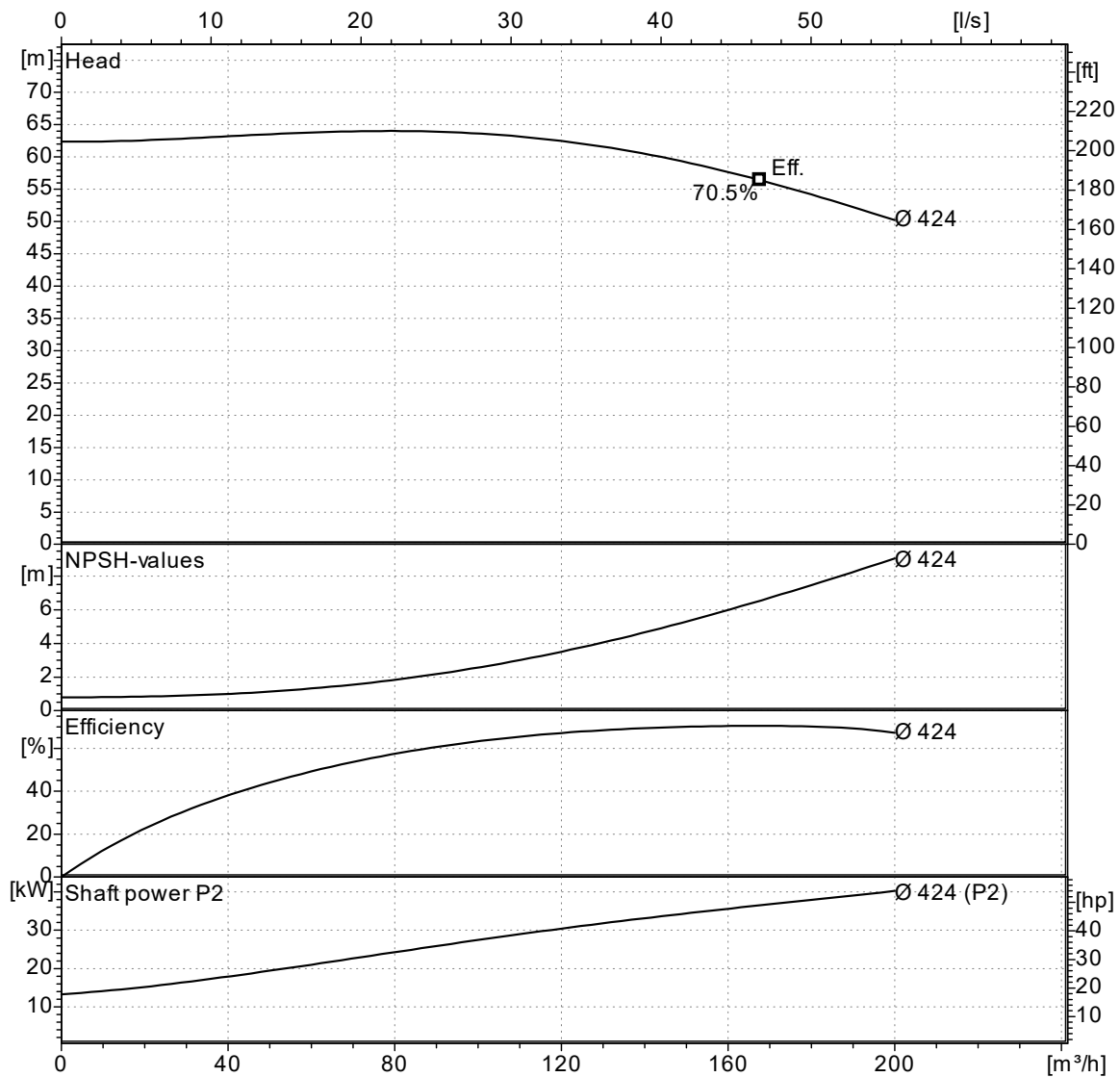

Curves compatible with ISO 9906:2012 Gr 3B

NPSHa > NPSHr + 1m

Note : The motor power is not sufficient for dotted area.

Company		Date	31/01/2023
Project		Item	
		Ref No.	

ECO SNM 80-400

Horizontal, single stage, radially split, closed-coupled, volute casing type conforming to EN 733 and EU 547/2012

Pump Dimensions

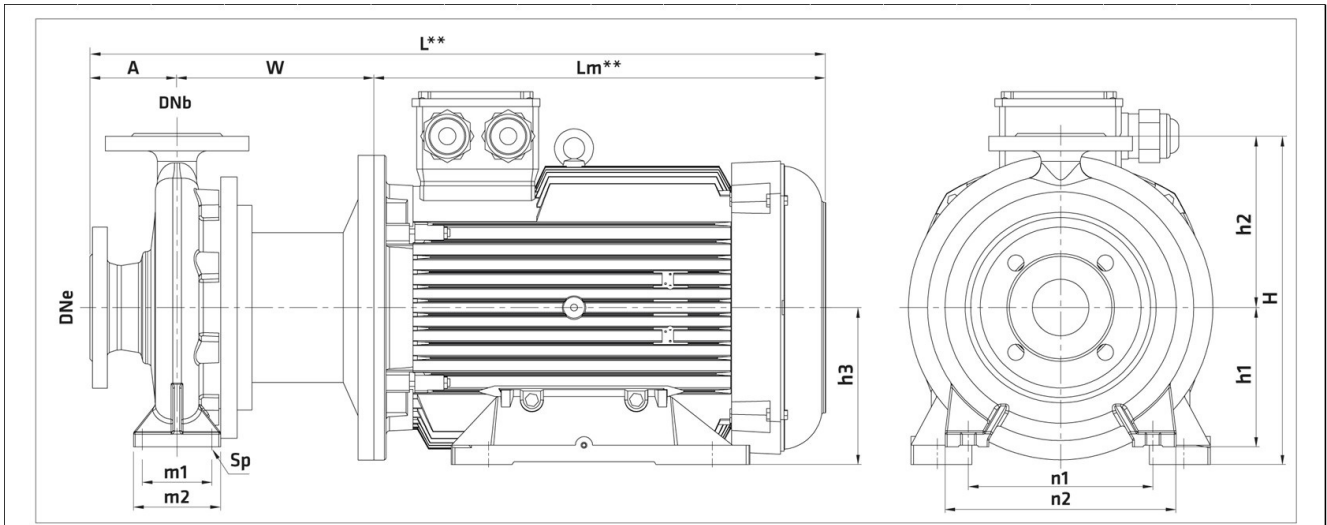

** Ölçüler motor üreticisine göre değişiklik gösterebilir. / ** Differs according to motor manufacturer.

1500 rpm

	Motor		(mm)														
	kW	IEC	DNe	DNb	A	W	Lm**	L**	H	h1	h2	h3	m1	m2	n1	n2	Sp
80-400	18,5	180M	100	80	125	256	519	900	635	280	355	180	120	160	355	435	19
80-400	22	180L	100	80	125	256	519	900	635	280	355	180	120	160	355	435	19
80-400	30	200L	100	80	125	256	555	936	635	280	355	200	120	160	355	435	19
80-400	37	225M	100	80	125	316	625	1068	635	280	355	225	120	160	355	435	19
80-400	45	225M	100	80	125	316	625	1068	635	280	355	225	120	160	355	435	19

Flange Dimensions

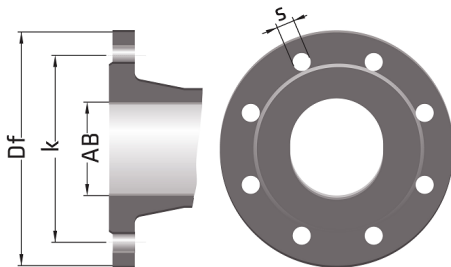

Suction Flange

AB = 100
Df = 220
k = 180
n = 8
s = 19

Discharge Flange

AB = 80
Df = 200
k = 160
n = 8
s = 19

" n " number of holes

Company		Date	31/01/2023
Project		Item	
		Ref No.	

ECO SNM 80-400

Horizontal, single stage, radially split, closed-coupled, volute casing type conforming to EN 733 and EU 547/2012

Motor Data

Efficiency Level	:	
Motor type	:	Three-Phase Asynchronous Motor
Motor Power	:	45.0 kW
Rated Speed	:	1450 rpm
Voltage	:	400 V
Rated Current	:	0.00 A
Frequency	:	50 Hz
Motor Phase	:	3
Service Factor	:	1.15
Insulation Class	:	F
Degree of Protection	:	IP 55
Efficiency	:	- %
Power factor	:	0.00