

## DATA SHEET

Company		Date	30/01/2023
Project		Item	
		Ref No.	

### SNSM 50-160-1.1

Horizontal, single stage, radially split, closed-coupled, volute casing type conforming to EN 733 and EU 547/2012

#### Operating Point Data

---

Capacity	:	Power at Duty Point	:
Head	:	Frequency	: 50 Hz
Efficiency (%)	:	Voltage	: 400 V
Impeller Diameter	: 160 mm	Motor Power	: 1.10 kW
NPSHr	:	Nominal Speed	: 1440 rpm
Shut Off Head	: 8.3 m		

#### Liquid Data

---

Liquid	: Water	Density	: 998.30 kg/m <sup>3</sup>
Temperature	: 20 °C	Viscosity	: 1.005 cSt

#### Pump Data

---

Design	: Single Stage, End Suction, Monoblock		
Installation	: Horizontal	Direction Of Rotation	: Clockwise from the drive end
Suction Flange	: EN 1092 PN 16-DN 65	Impeller Type	: Radial impeller
Discharge Flange	: EN 1092 PN 16-DN 50	Type of Shaft Sealing	: Mechanical Seal
Pressure rating	: PN10		

Minimum Efficiency Index (MEI) >= 0,4

#### Materials

---

Volute Casing	0.6025 / GG25 / EN-GJL-250 / ASTM A48 Class 40B
Casing Cover	0.6025 / GG25 / EN-GJL-250 / ASTM A48 Class 40B
Impeller	0.6025 / GG25 / EN-GJL-250 / ASTM A48 Class 40B
Shaft	1.4021 / X20Cr13 / ASTM A276 Type 420
Mechanical Seal Sleeve	1.4021 / X20Cr13 / ASTM A276 Type 420
Motor Pedestal	0.6025 / GG25 / EN-GJL-250 / ASTM A48 Class 40B

## Operating Point Data

Company		Date	30/01/2023
Project		Item	
		Ref No.	

### SNSM 50-160-1.1

Horizontal, single stage, radially split, closed-coupled, volute casing type conforming to EN 733 and EU 547/2012

Capacity:		NPSHr:	
Head:		Motor Power:	1.10 kW
Efficiency (%):		Nominal Speed:	1440 rpm
Power at Duty Point:		Frequency:	50 Hz
Viscosity:	1.005 cSt	Density:	998.30 kg/m <sup>3</sup>

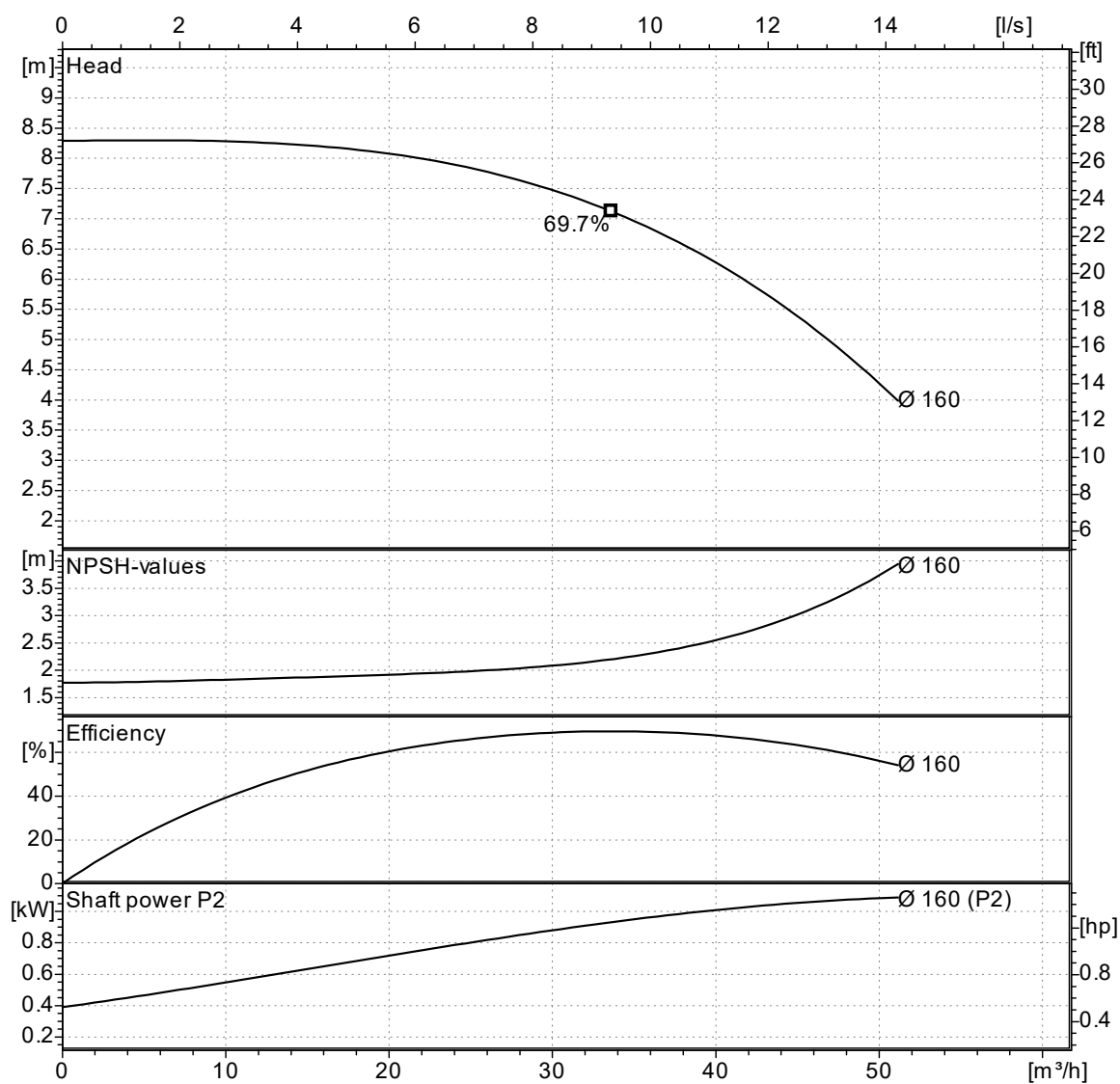

Curves compatible with ISO 9906:2012 Gr 3B

NPSHa > NPSHr + 1m

Note : The motor power is not sufficient for dotted area.

Company		Date	30/01/2023
Project		Item	
		Ref No.	

## SNSM 50-160-1.1

Horizontal, single stage, radially split, closed-coupled, volute casing type conforming to EN 733 and EU 547/2012

### Pump Dimensions

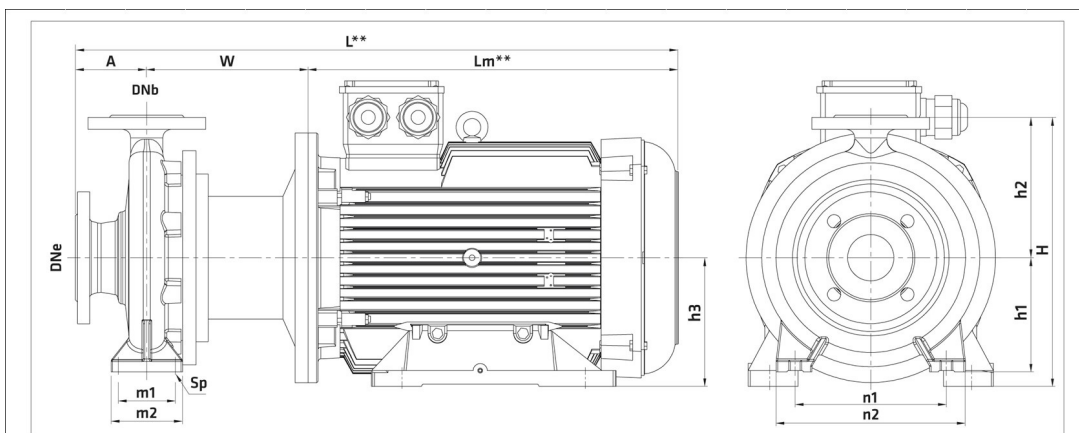

\*\* Ölçüler motor üreticisine göre değişkenlik gösterebilir. / \*\* Differs according to motor manufacturer.

3000 rpm																	
	Motor		DNe	DNb	A	W	Lm**	L**	H	h1	h2	h3	m1	m2	n1	n2	Sp
	kW	IEC															
50-160	5,5	132S	65	50	100	189	360	649	340	160	180	132	70	100	212	265	14
50-160	7,5	132M	65	50	100	189	396	685	340	160	180	132	70	100	212	265	14
50-160	11	160M	65	50	100	226	466	792	340	160	180	160	70	100	212	265	14
50-160	15	160L	65	50	100	226	466	792	340	160	180	160	70	100	212	265	14

1500 rpm																	
	Motor		DNe	DNb	A	W	Lm**	L**	H	h1	h2	h3	m1	m2	n1	n2	Sp
	kW	IEC															
50-160	0,75	80M	65	50	100	156	243	500	340	160	180	80	70	100	212	265	14
50-160	1,1	90L	65	50	100	156	267	523	340	160	180	90	70	100	212	265	14
50-160	1,5	90L	65	50	100	156	267	523	340	160	180	90	70	100	212	265	14
50-160	2,2	100L	65	50	100	179	292	571	340	160	180	100	70	100	212	265	14

### Flange Dimensions

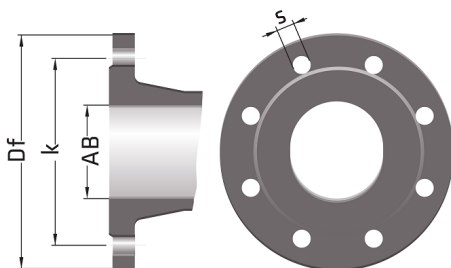

#### Suction Flange

AB = 65  
Df = 185  
k = 145  
n = 4  
s = 19

#### Discharge Flange

AB = 50  
Df = 165  
k = 125  
n = 4  
s = 19

" n " number of holes

Company		Date	30/01/2023
Project		Item	
		Ref No.	

**SNSM 50-160-1.1**

Horizontal, single stage, radially split, closed-coupled, volute casing type conforming to EN 733 and EU 547/2012

**Motor Data**

---

Efficiency Level :  
 Motor type : Three-Phase Asynchronous Motor  
 Motor Power : 1.1 kW  
 Rated Speed : 1450 rpm  
 Voltage : 400 V  
 Rated Current : 0.00 A  
 Frequency : 50 Hz  
 Motor Phase : 3  
 Service Factor : 1.15  
 Insulation Class : F  
 Degree of Protection : IP 55  
 Efficiency : - %  
 Power factor : 0.00