

DATA SHEET

Company		Date	26/01/2023
Project		Item	
		Ref No.	

SNSM 40-125-2.2

Horizontal, single stage, radially split, closed-coupled, volute casing type conforming to EN 733 and EU 547/2012

Operating Point Data

Capacity	:	Power at Duty Point	:
Head	:	Frequency	: 50 Hz
Efficiency (%)	:	Voltage	: 380 V
Impeller Diameter	: 120 mm	Motor Power	: 2.20 kW
NPSHr	:	Nominal Speed	: 2880 rpm
Shut Off Head	: 18.3 m		

Liquid Data

Liquid	: Water	Density	: 998.30 kg/m ³
Temperature	: 20 °C	Viscosity	: 1.005 cSt

Pump Data

Design	: Single Stage, End Suction, Monoblock		
Installation	: Horizontal	Direction Of Rotation	: Clockwise from the drive end
Suction Flange	: EN 1092 PN 16-DN 65	Impeller Type	: Radial impeller
Discharge Flange	: EN 1092 PN 16-DN 40	Type of Shaft Sealing	: Mechanical Seal
Pressure rating	: PN10		

Minimum Efficiency Index (MEI) >= 0,4

Materials

Volute Casing	0.6025 / GG25 / EN-GJL-250 / ASTM A48 Class 40B
Casing Cover	0.6025 / GG25 / EN-GJL-250 / ASTM A48 Class 40B
Impeller	0.6025 / GG25 / EN-GJL-250 / ASTM A48 Class 40B
Shaft	1.4021 / X20Cr13 / ASTM A276 Type 420
Mechanical Seal Sleeve	1.4021 / X20Cr13 / ASTM A276 Type 420
Motor Pedestal	0.6025 / GG25 / EN-GJL-250 / ASTM A48 Class 40B

Operating Point Data

Company		Date	26/01/2023
Project		Item	
		Ref No.	

SNSM 40-125-2.2

Horizontal, single stage, radially split, closed-coupled, volute casing type conforming to EN 733 and EU 547/2012

Capacity:		NPSHr:	
Head:		Motor Power:	2.20 kW
Efficiency (%):		Nominal Speed:	2880 rpm
Power at Duty Point:		Frequency:	50 Hz
Viscosity:	1.005 cSt	Density:	998.30 kg/m ³

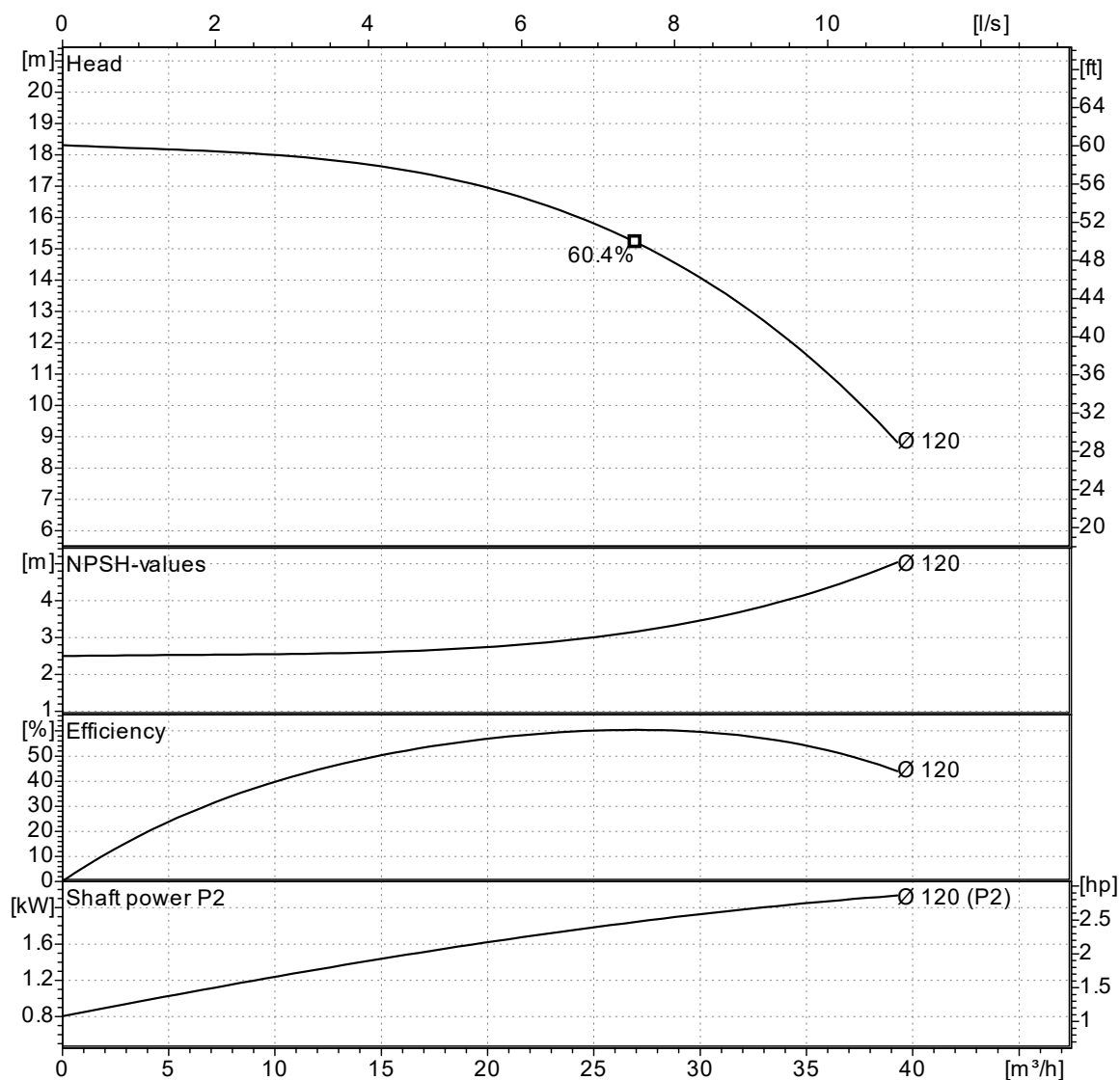

Curves compatible with ISO 9906:2012 Gr 3B

NPSHa > NPSHr + 1m

Note : The motor power is not sufficient for dotted area.

Company		Date	26/01/2023
Project		Item	
		Ref No.	

SNSM 40-125-2.2

Horizontal, single stage, radially split, closed-coupled, volute casing type conforming to EN 733 and EU 547/2012

Pump Dimensions

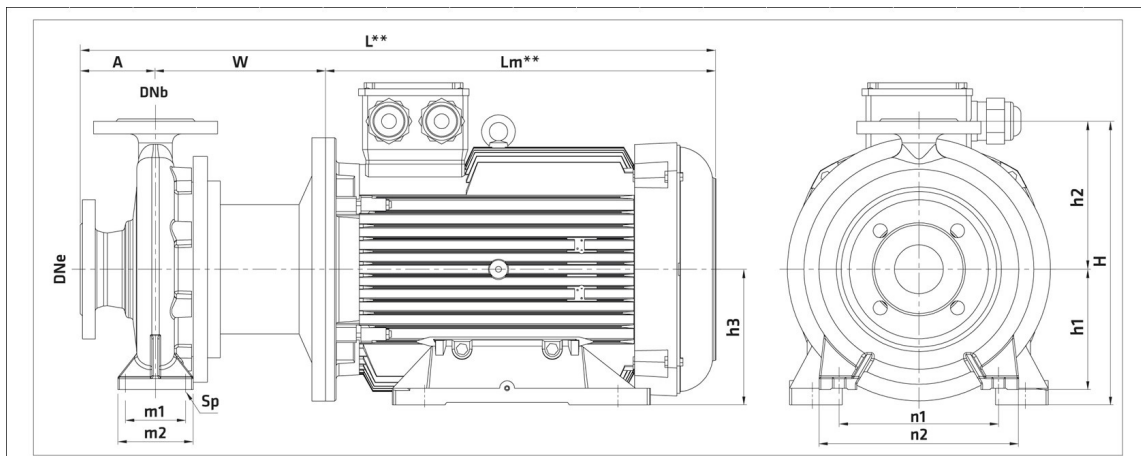

** Ölçüler motor üreticisine göre değişiklik gösterebilir. / ** Differs according to motor manufacturer.

3000 rpm																	
	Motor		DNe	DNb	A	W	Lm**	L**	H	h1	h2	h3	m1	m2	n1	n2	Sp
	kW	IEC															
40-125	2,2	90L	65	40	80	156	267	503	252	112	140	90	70	100	160	210	14
40-125	3	100L	65	40	80	179	292	551	252	112	140	100	70	100	160	210	14
40-125	4	112M	65	40	80	179	335	594	252	112	140	112	70	100	160	210	14
40-125	5,5	132S	65	40	80	189	360	629	252	112	140	132	70	100	160	210	14

1500 rpm																	
	Motor		DNe	DNb	A	W	Lm**	L**	H	h1	h2	h3	m1	m2	n1	n2	Sp
	kW	IEC															
40-125	0,37	71M	65	40	80	136	223	439	252	112	140	71	70	100	160	210	14
40-125	0,55	80M	65	40	80	156	243	479	252	112	140	80	70	100	160	210	14

Flange Dimensions



Suction Flange

AB = 65
Df = 185
k = 145
n = 4
s = 19

Discharge Flange

AB = 40
Df = 150
k = 100
n = 4
s = 19

" n " number of holes

Company		Date	26/01/2023
Project		Item	
		Ref No.	

SNSM 40-125-2.2

Horizontal, single stage, radially split, closed-coupled, volute casing type conforming to EN 733 and EU 547/2012

Motor Data

Efficiency Level :
 Motor type : Three-Phase Asynchronous Motor
 Motor Power : 2.2 kW
 Rated Speed : 2950 rpm
 Voltage : 380 V
 Rated Current : 0.00 A
 Frequency : 50 Hz
 Motor Phase : 3
 Service Factor : 1.15
 Insulation Class : F
 Degree of Protection : IP 55
 Efficiency : - %
 Power factor : 0.00