

DATA SHEET

| | | | |
|---------|--|---------|------------|
| Company | | Date | 25/01/2023 |
| Project | | Item | |
| | | Ref No. | |

SNSM 32-160-5.5

Horizontal, single stage, radially split, closed-coupled, volute casing type conforming to EN 733 and EU 547/2012

Operating Point Data

| | | | |
|-------------------|----------|---------------------|------------|
| Capacity | : | Power at Duty Point | : |
| Head | : | Frequency | : 50 Hz |
| Efficiency (%) | : | Voltage | : 380 V |
| Impeller Diameter | : 179 mm | Motor Power | : 5.50 kW |
| NPSHr | : | Nominal Speed | : 2900 rpm |
| Shut Off Head | : 44.0 m | | |

Liquid Data

| | | | |
|-------------|---------|-----------|----------------------------|
| Liquid | : Water | Density | : 998.30 kg/m ³ |
| Temperature | : 20 °C | Viscosity | : 1.005 cSt |

Pump Data

| | | | |
|------------------|--|-----------------------|--------------------------------|
| Design | : Single Stage, End Suction, Monoblock | | |
| Installation | : Horizontal | Direction Of Rotation | : Clockwise from the drive end |
| Suction Flange | : EN 1092 PN 16-DN 50 | Impeller Type | : Radial impeller |
| Discharge Flange | : EN 1092 PN 16-DN 32 | Type of Shaft Sealing | : Mechanical Seal |
| Pressure rating | : PN10 | | |

Minimum Efficiency Index (MEI) >= 0,4

Materials

| | |
|------------------------|---|
| Volute Casing | 0.6025 / GG25 / EN-GJL-250 / ASTM A48 Class 40B |
| Casing Cover | 0.6025 / GG25 / EN-GJL-250 / ASTM A48 Class 40B |
| Impeller | 0.6025 / GG25 / EN-GJL-250 / ASTM A48 Class 40B |
| Shaft | 1.4021 / X20Cr13 / ASTM A276 Type 420 |
| Mechanical Seal Sleeve | 1.4021 / X20Cr13 / ASTM A276 Type 420 |
| Motor Pedestal | 0.6025 / GG25 / EN-GJL-250 / ASTM A48 Class 40B |

Operating Point Data

| | | | |
|---------|--|---------|------------|
| Company | | Date | 25/01/2023 |
| Project | | Item | |
| | | Ref No. | |

SNSM 32-160-5.5

Horizontal, single stage, radially split, closed-coupled, volute casing type conforming to EN 733 and EU 547/2012

| | | | |
|----------------------|-----------|----------------|--------------------------|
| Capacity: | | NPSHr: | |
| Head: | | Motor Power: | 5.50 kW |
| Efficiency (%): | | Nominal Speed: | 2900 rpm |
| Power at Duty Point: | | Frequency: | 50 Hz |
| Viscosity: | 1.005 cSt | Density: | 998.30 kg/m ³ |

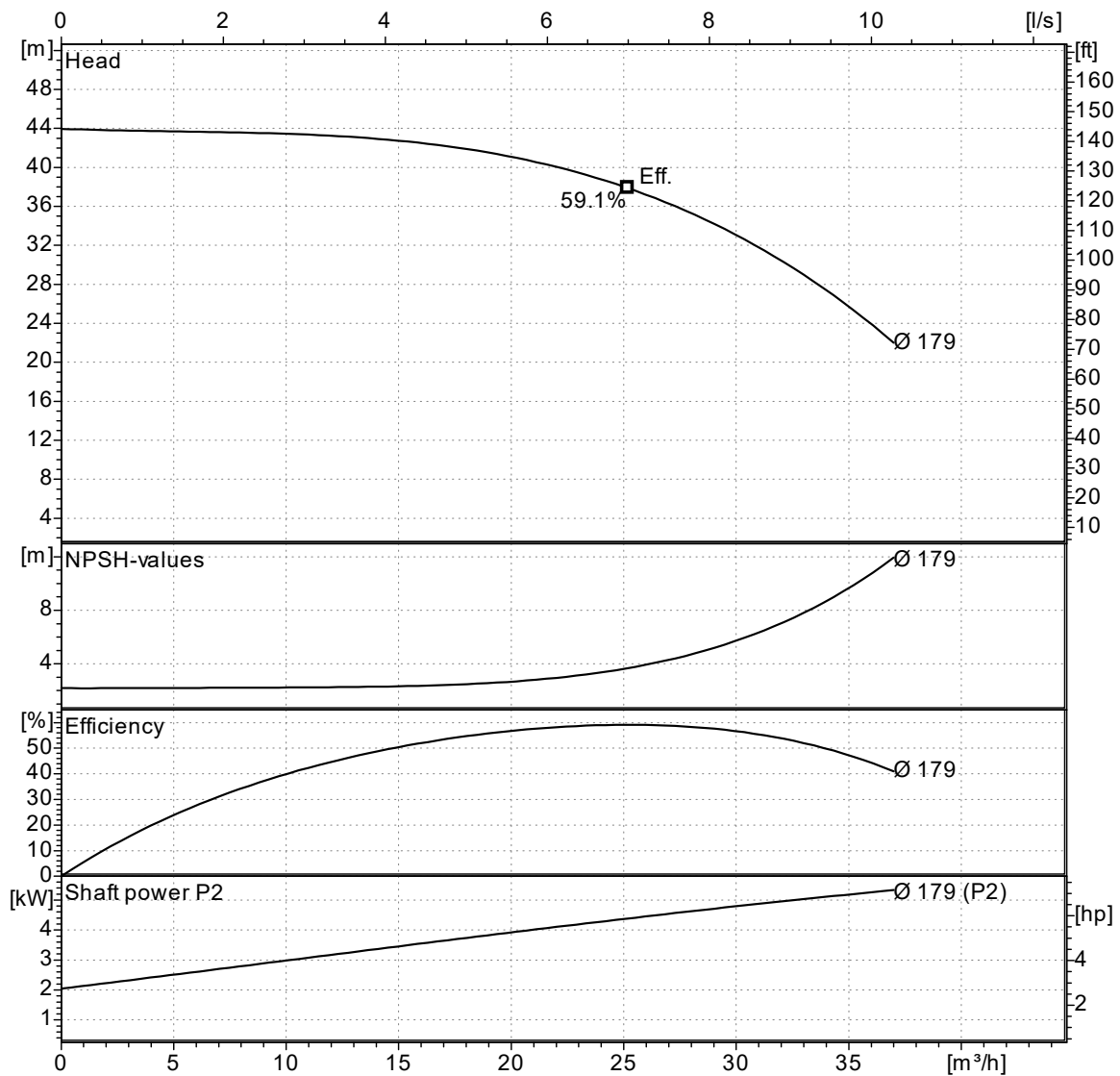

Curves compatible with ISO 9906:2012 Gr 3B

NPSHa > NPSHr + 1m

Note : The motor power is not sufficient for dotted area.

| | | | |
|---------|--|---------|------------|
| Company | | Date | 25/01/2023 |
| Project | | Item | |
| | | Ref No. | |

SNSM 32-160-5.5

Horizontal, single stage, radially split, closed-coupled, volute casing type conforming to EN 733 and EU 547/2012

Pump Dimensions

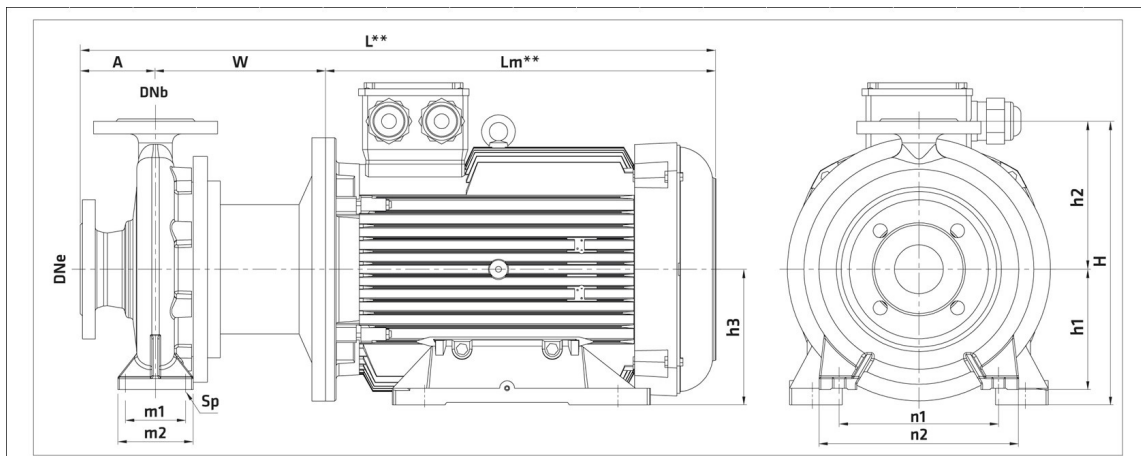

** Ölçüler motor üreticisine göre değişiklik gösterebilir. / ** Differs according to motor manufacturer.

| 3000 rpm | | | | | | | | | | | | | | | | | |
|----------|-------|------|-----|-----|----|-----|------|-----|-----|-----|-----|-----|----|-----|-----|-----|----|
| | Motor | | DNe | DNb | A | W | Lm** | L** | H | h1 | h2 | h3 | m1 | m2 | n1 | n2 | Sp |
| | kW | IEC | | | | | | | | | | | | | | | |
| 32-160 | 2,2 | 90L | 50 | 32 | 80 | 156 | 267 | 503 | 292 | 132 | 160 | 90 | 70 | 100 | 190 | 240 | 14 |
| 32-160 | 3 | 100L | 50 | 32 | 80 | 179 | 292 | 551 | 292 | 132 | 160 | 100 | 70 | 100 | 190 | 240 | 14 |
| 32-160 | 4 | 112M | 50 | 32 | 80 | 179 | 336 | 595 | 292 | 132 | 160 | 112 | 70 | 100 | 190 | 240 | 14 |
| 32-160 | 5,5 | 132S | 50 | 32 | 80 | 189 | 360 | 629 | 292 | 132 | 160 | 132 | 70 | 100 | 190 | 240 | 14 |
| 1500 rpm | | | | | | | | | | | | | | | | | |
| | Motor | | DNe | DNb | A | W | Lm** | L** | H | h1 | h2 | h3 | m1 | m2 | n1 | n2 | Sp |
| | kW | IEC | | | | | | | | | | | | | | | |
| 32-160 | 0,37 | 71M | 50 | 32 | 80 | 136 | 222 | 439 | 292 | 132 | 160 | 71 | 70 | 100 | 190 | 240 | 14 |
| 32-160 | 0,55 | 80M | 50 | 32 | 80 | 156 | 244 | 480 | 292 | 132 | 160 | 80 | 70 | 100 | 190 | 240 | 14 |
| 32-160 | 0,75 | 80M | 50 | 32 | 80 | 156 | 244 | 480 | 292 | 132 | 160 | 80 | 70 | 100 | 190 | 240 | 14 |

Flange Dimensions



Suction Flange

AB = 50
Df = 165
k = 125
n = 4
s = 19

Discharge Flange

AB = 32
Df = 140
k = 100
n = 4
s = 19

" n " number of holes

| | | | |
|---------|--|---------|------------|
| Company | | Date | 25/01/2023 |
| Project | | Item | |
| | | Ref No. | |

SNSM 32-160-5.5

Horizontal, single stage, radially split, closed-coupled, volute casing type conforming to EN 733 and EU 547/2012

Motor Data

Efficiency Level :
 Motor type : Three-Phase Asynchronous Motor
 Motor Power : 5.5 kW
 Rated Speed : 2950 rpm
 Voltage : 380 V
 Rated Current : 0.00 A
 Frequency : 50 Hz
 Motor Phase : 3
 Service Factor : 1.15
 Insulation Class : F
 Degree of Protection : IP 55
 Efficiency : - %
 Power factor : 0.00