

DATA SHEET

Company		Date	31/01/2023
Project		Item	
		Ref No.	

SNSM 125-400-37

Horizontal, single stage, radially split, closed-coupled, volute casing type conforming to EN 733 and EU 547/2012

Operating Point Data

Capacity	:	Power at Duty Point	:
Head	:	Frequency	: 50 Hz
Efficiency (%)	:	Voltage	: 400 V
Impeller Diameter	: 342 mm	Motor Power	: 37.00 kW
NPSHr	:	Nominal Speed	: 1480 rpm
Shut Off Head	: 39.1 m		

Liquid Data

Liquid	: Water	Density	: 998.30 kg/m ³
Temperature	: 20 °C	Viscosity	: 1.005 cSt

Pump Data

Design	: Single Stage, End Suction, Monoblock		
Installation	: Horizontal	Direction Of Rotation	: Clockwise from the drive end
Suction Flange	: EN 1092 PN 16-DN 150	Impeller Type	:
Discharge Flange	: EN 1092 PN 16-DN 125	Type of Shaft Sealing	: Mechanical Seal
Pressure rating	: PN10		

Minimum Efficiency Index (MEI) >= 0,4

Materials

Volute Casing	0.6025 / GG25 / EN-GJL-250 / ASTM A48 Class 40B
Casing Cover	0.6025 / GG25 / EN-GJL-250 / ASTM A48 Class 40B
Impeller	0.6025 / GG25 / EN-GJL-250 / ASTM A48 Class 40B
Shaft	1.4021 / X20Cr13 / ASTM A276 Type 420
Mechanical Seal Sleeve	1.4021 / X20Cr13 / ASTM A276 Type 420
Motor Pedestal	0.6025 / GG25 / EN-GJL-250 / ASTM A48 Class 40B

Operating Point Data

Company		Date	31/01/2023
Project		Item	
		Ref No.	

SNSM 125-400-37

Horizontal, single stage, radially split, closed-coupled, volute casing type conforming to EN 733 and EU 547/2012

Capacity:		NPSHr:	
Head:		Motor Power:	37.00 kW
Efficiency (%):		Nominal Speed:	1480 rpm
Power at Duty Point:		Frequency:	50 Hz
Viscosity:	1.005 cSt	Density:	998.30 kg/m ³

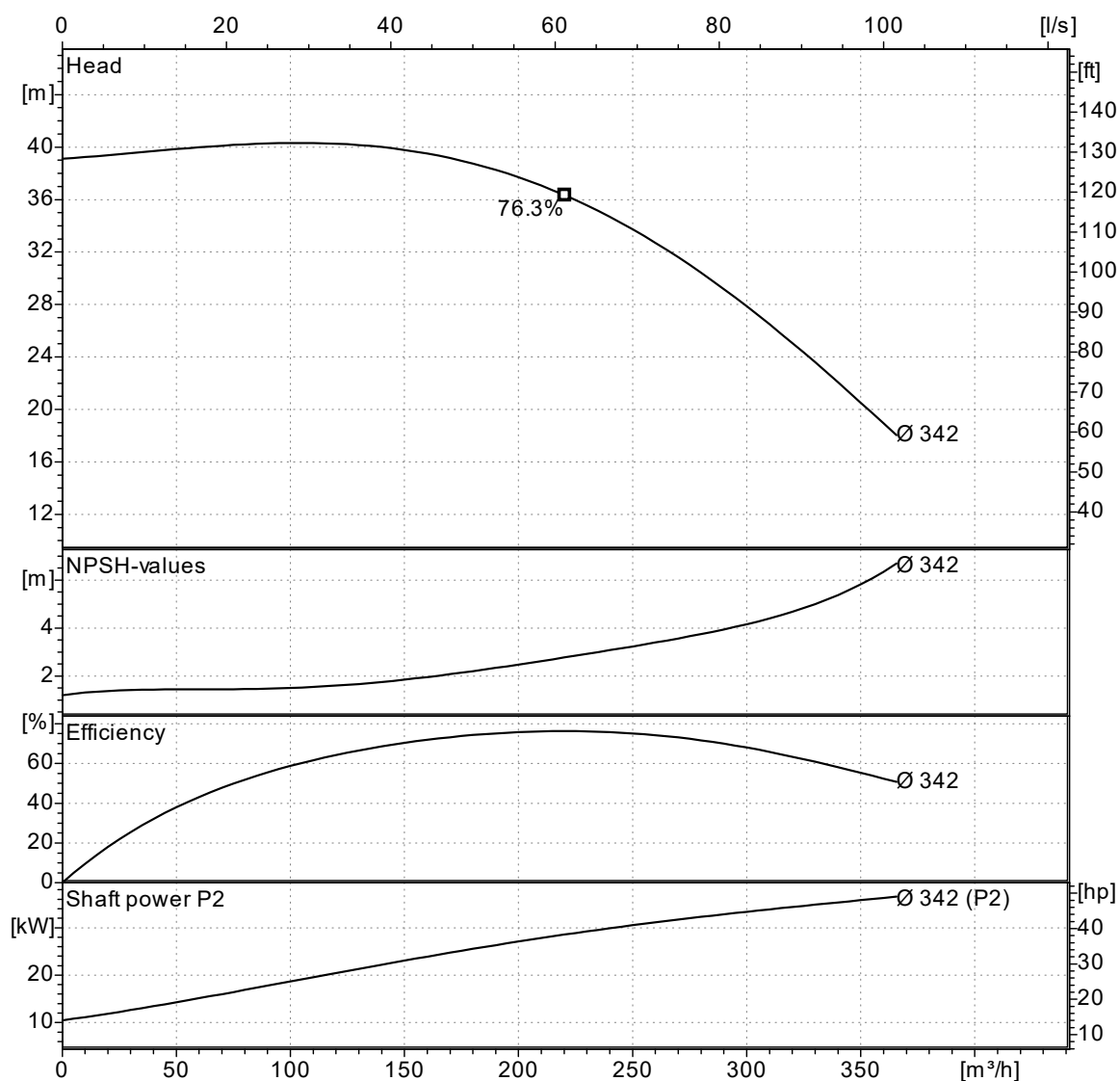

Curves compatible with ISO 9906:2012 Gr 3B

NPSHa > NPSHr + 1m

Note : The motor power is not sufficient for dotted area.

Company		Date	31/01/2023
Project		Item	
		Ref No.	

SNSM 125-400-37

Horizontal, single stage, radially split, closed-coupled, volute casing type conforming to EN 733 and EU 547/2012

Pump Dimensions

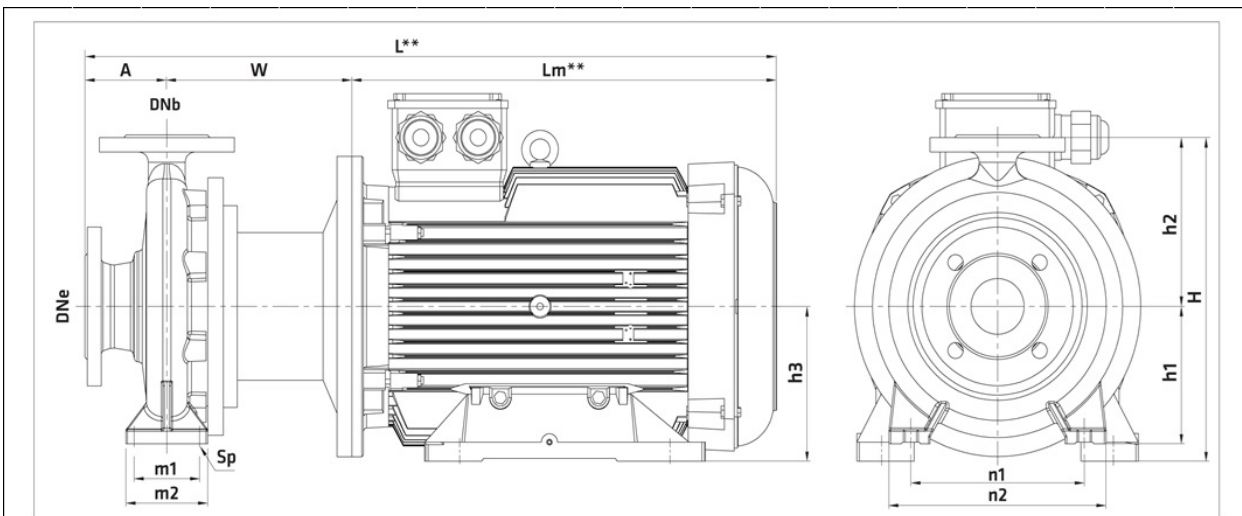

** Ölçüler motor üreticisine göre değişiklik gösterebilir. / ** Differs according to motor manufacturer.

		1500 rpm																
		Motor		(mm)														
		kW	IEC	DNe	DNb	A	W	Lm**	L**	H	h1	h2	h3	m1	m2	n1	n2	Sp
125-400	37	225M	150	125	140	316	625	1081	715	315	400	225	150	200	400	500	23	
125-400	45	225M	150	125	140	316	625	1081	715	315	400	225	150	200	400	500	23	
125-400	55	250M	150	125	140	316	753	1209	715	315	400	250	150	200	400	500	23	
125-400	75	280M	150	125	140	316	869	1325	715	315	400	280	150	200	400	500	23	
125-400	90	280M	150	125	140	316	869	1325	715	315	400	280	150	200	400	500	23	

Flange Dimensions



Suction Flange

AB = 150
Df = 285
k = 240
n = 8
s = 23

Discharge Flange

AB = 125
Df = 250
k = 210
n = 8
s = 19

" n " number of holes

Company		Date	31/01/2023
Project		Item	
		Ref No.	

SNSM 125-400-37

Horizontal, single stage, radially split, closed-coupled, volute casing type conforming to EN 733 and EU 547/2012

Motor Data

Efficiency Level :
 Motor type : Three-Phase Asynchronous Motor
 Motor Power : 37.0 kW
 Rated Speed : 1450 rpm
 Voltage : 400 V
 Rated Current : 0.00 A
 Frequency : 50 Hz
 Motor Phase : 3
 Service Factor : 1.15
 Insulation Class : F
 Degree of Protection : IP 55
 Efficiency : - %
 Power factor : 0.00