

## DATA SHEET

Company		Date	15/02/2023
Project		Item	
		Ref No.	

### SNDS 80-200-45

Horizontal, double suction, single stage, axially split volute casing pump

#### Operating Point Data

---

Capacity	:	Power at Duty Point	:
Head	:	Frequency	: 50 Hz
Efficiency (%)	:	Voltage	: 380 V
Impeller Diameter	: 216 mm	Motor Power	: 45.00 kW
NPSHr	:	Nominal Speed	: 2960 rpm
Shut Off Head	: 65.6 m		

#### Liquid Data

---

Liquid	: Water	Density	: 998.30 kg/m <sup>3</sup>
Temperature	: 20 °C	Viscosity	: 1.005 mm <sup>2</sup> /s

#### Pump Data

---

Design	: Double suction, Single stage	Type of Coupling	: Standard
Installation	: Horizontal	Impeller Type	: Double Suction
Suction Flange	: EN 1092 PN 16-DN 125	Type of Bearing	: Grease Lubricated Bearing
Discharge Flange	: EN 1092 PN 16-DN 80	Type of Shaft Sealing	: Soft Packing
Direction Of Rotation	: Clockwise from the drive end		

#### Materials

---

Volute Casing	0.6025 / GG25 / EN-GJL-250 / ASTM A48 Class 40B
Impeller	0.6025 / GG25 / EN-GJL-250 / ASTM A48 Class 40B
Shaft	1.4021 / X20Cr13 / ASTM A276 Type 420
Bearing Housing	0.6025 / GG25 / EN-GJL-250 / ASTM A48 Class 40B
Casing Wear Ring	2.1050.01 / G-CuSn10 / ASTM B427 C90700
Shaft Protecting Sleeve	1.4021 / X20Cr13 / ASTM A276 Type 420

## Operating Point Data

Company		Date	15/02/2023
Project		Item	
		Ref No.	

### SNDS 80-200-45

Horizontal, double suction, single stage, axially split volute casing pump

Capacity:		NPSHr:	
Head:		Motor Power:	45.00 kW
Efficiency (%):		Nominal Speed:	2960 rpm
Power at Duty Point:		Frequency:	50 Hz
Viscosity:	1.005 mm <sup>2</sup> /s	Density:	998.30 kg/m <sup>3</sup>

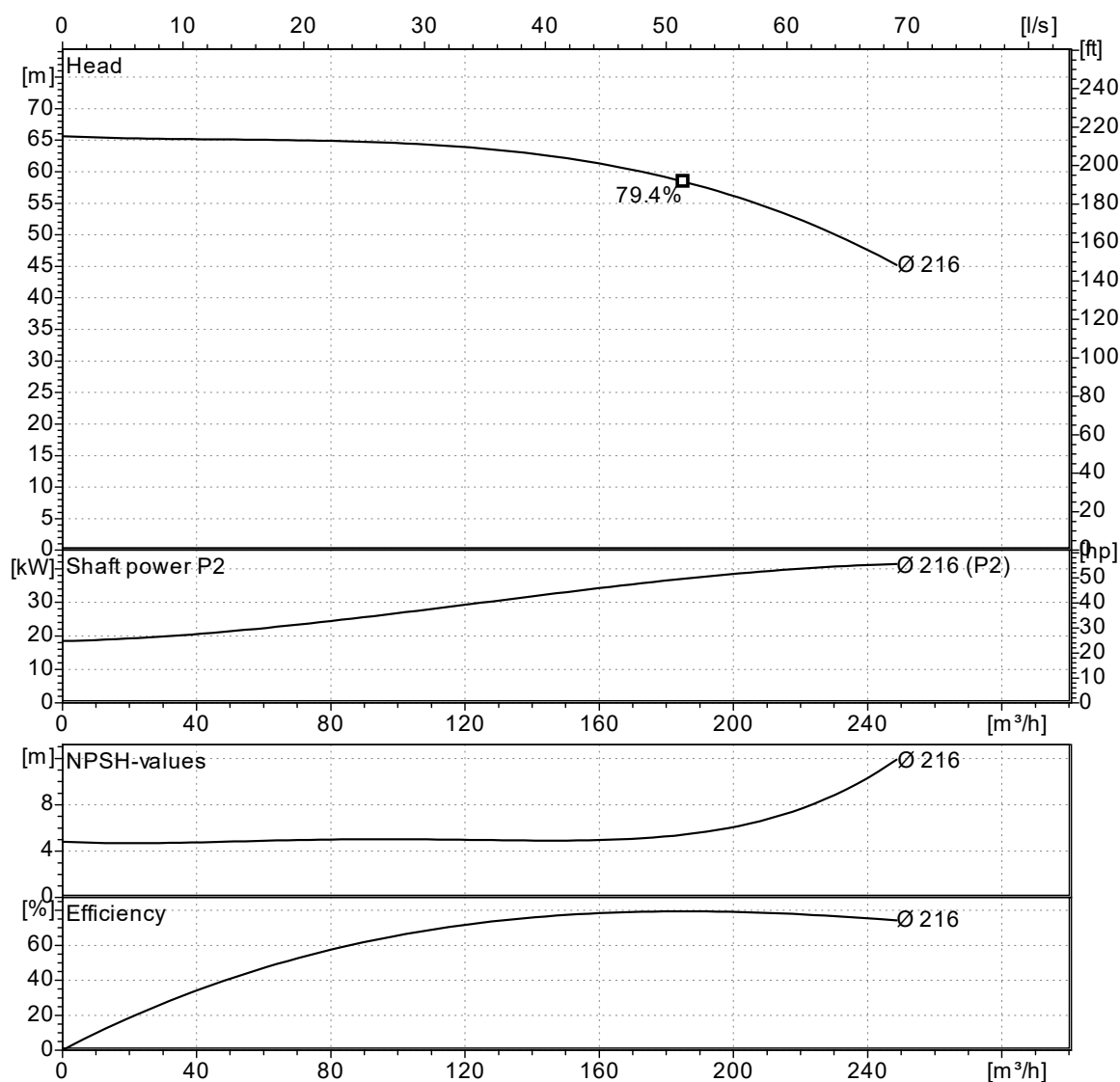

Curves compatible with ISO 9906:2012 Gr 3B

NPSHa > NPSHr + 1m

Note : The motor power is not sufficient for dotted area.

Company		Date	15/02/2023
Project		Item	
		Ref No.	

**SNDS 80-200-45**

Horizontal, double suction, single stage, axially split volute casing pump

**Pump Dimensions**

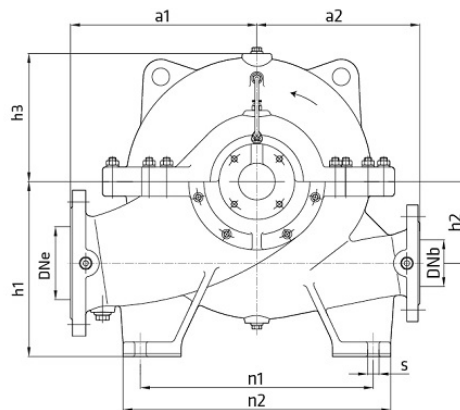
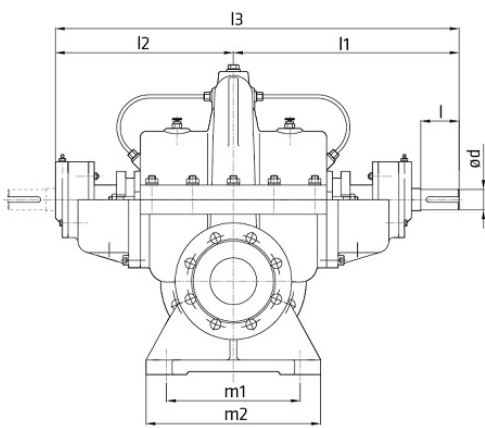

Name	Value
a1	320
a2	280
d	35
DNb	80
DNe	125
h1	300
h2	140
h3	200
l	80
l1	400
l2	310
l3	710
m1	230
m2	300
n1	400
n2	460
s	20
W	165 kg

Note : l1 and l2 replaced each other since pump shaft rotates counter-clockw ise.

**Flange Dimensions**



Suction Flange	Discharge Flange
AB = 125	AB = 80
Df = 250	Df = 200
k = 210	k = 160
n = 8	n = 8
s = 19	s = 19

" n " number of holes

Company		Date	15/02/2023
Project		Item	
		Ref No.	

**SNDS 80-200-45**

Horizontal, double suction, single stage, axially split volute casing pump

**Motor Data**

---

Efficiency Level :  
 Motor type : Three-Phase Asynchronous Motor  
 Motor Power : 45.0 kW  
 Rated Speed : 2950 rpm  
 Voltage : 380 V  
 Rated Current : 0.00 A  
 Frequency : 50 Hz  
 Motor Phase : 3  
 Service Factor : 1.15  
 Insulation Class : F  
 Degree of Protection : IP 55  
 Efficiency : - %  
 Power factor : 0.00