

DATA SHEET

Company		Date	15/02/2023
Project		Item	
		Ref No.	

SNDS 100-315-18.5

Horizontal, double suction, single stage, axially split volute casing pump

Operating Point Data

Capacity	:	Power at Duty Point	:
Head	:	Frequency	: 50 Hz
Efficiency (%)	:	Voltage	: 400 V
Impeller Diameter	: 295 mm	Motor Power	: 18.50 kW
NPSHr	:	Nominal Speed	: 1460 rpm
Shut Off Head	: 30.6 m		

Liquid Data

Liquid	: Water	Density	: 998.30 kg/m ³
Temperature	: 20 °C	Viscosity	: 1.005 mm ² /s

Pump Data

Design	: Double suction, Single stage	Type of Coupling	: Standard
Installation	: Horizontal	Impeller Type	: Double Suction
Suction Flange	: EN 1092 PN 16-DN 150	Type of Bearing	: Grease Lubricated Bearing
Discharge Flange	: EN 1092 PN 16-DN 100	Type of Shaft Sealing	: Soft Packing
Direction Of Rotation	: Clockwise from the drive end		

Materials

Volute Casing	0.6025 / GG25 / EN-GJL-250 / ASTM A48 Class 40B
Impeller	0.6025 / GG25 / EN-GJL-250 / ASTM A48 Class 40B
Shaft	1.4021 / X20Cr13 / ASTM A276 Type 420
Bearing Housing	0.6025 / GG25 / EN-GJL-250 / ASTM A48 Class 40B
Casing Wear Ring	2.1050.01 / G-CuSn10 / ASTM B427 C90700
Shaft Protecting Sleeve	1.4021 / X20Cr13 / ASTM A276 Type 420

Operating Point Data

Company		Date	15/02/2023
Project		Item	
		Ref No.	

SNDS 100-315-18.5

Horizontal, double suction, single stage, axially split volute casing pump

Capacity:		NPSHr:	
Head:		Motor Power:	18.50 kW
Efficiency (%):		Nominal Speed:	1460 rpm
Power at Duty Point:		Frequency:	50 Hz
Viscosity:	1.005 mm ² /s	Density:	998.30 kg/m ³

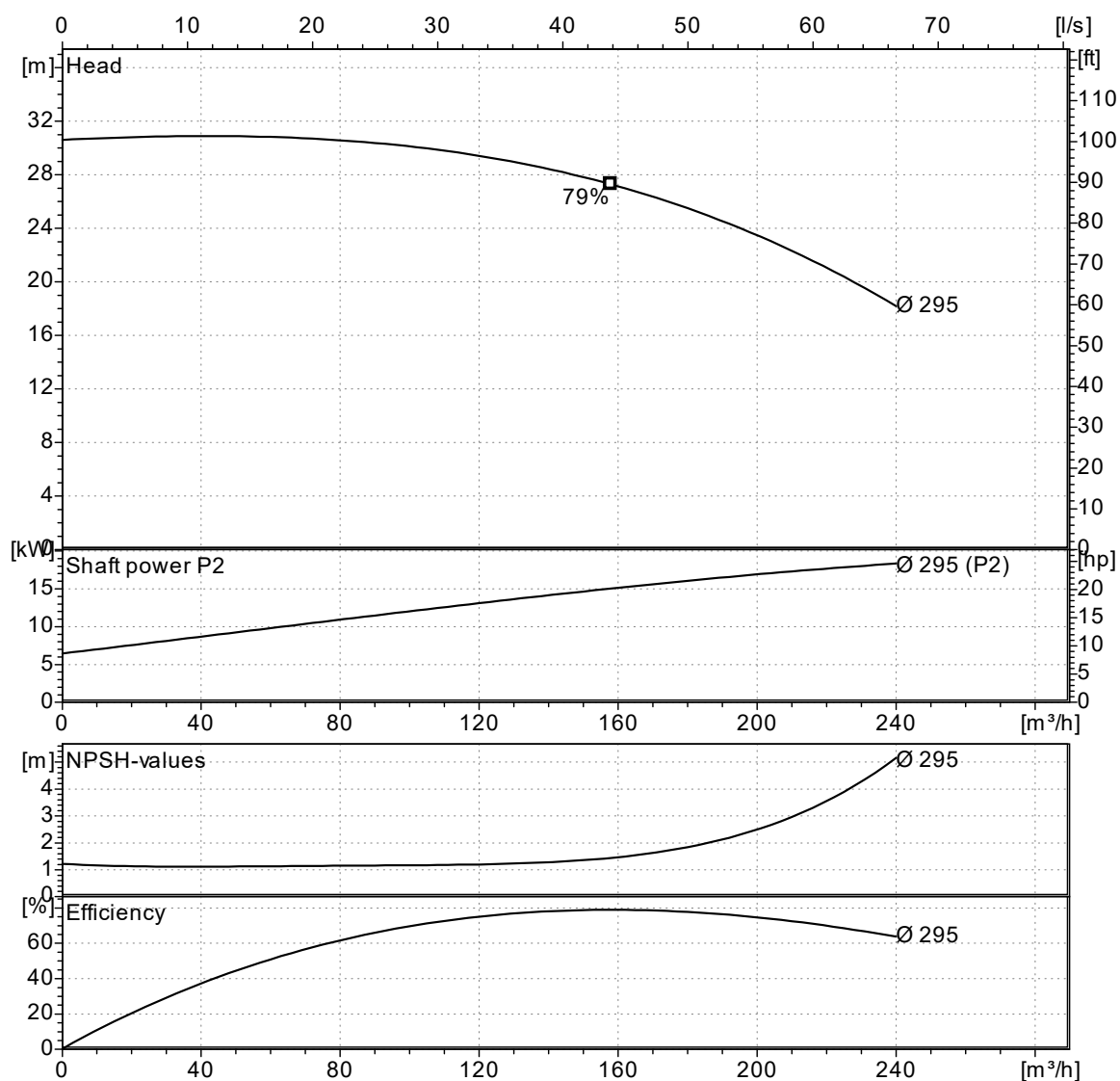

Curves compatible with ISO 9906:2012 Gr 3B

NPSHa > NPSHr + 1m

Note : The motor power is not sufficient for dotted area.

Company		Date	15/02/2023
Project		Item	
		Ref No.	

SNDS 100-315-18.5

Horizontal, double suction, single stage, axially split volute casing pump

Pump Dimensions

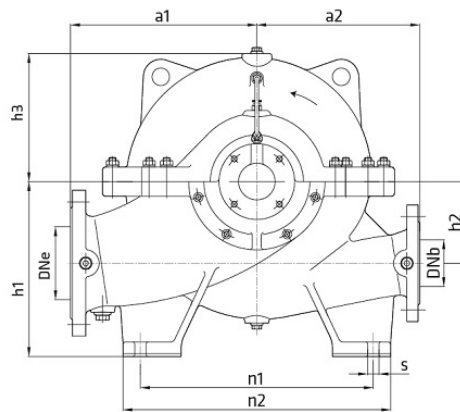
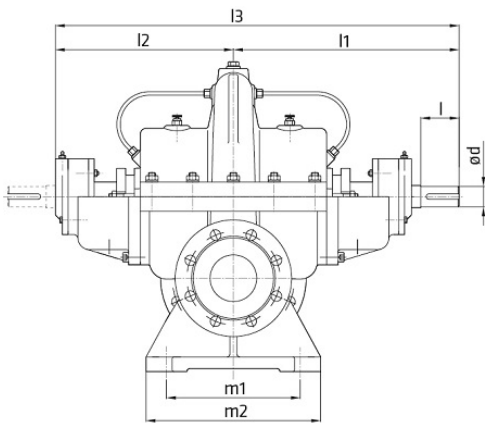

Name	Value
a1	360
a2	310
d	42
DNb	100
DNe	150
h1	355
h2	170
h3	250
l	90
l1	450
l2	350
l3	800
m1	280
m2	340
n1	400
n2	480
s	20
W	230 kg

Note : l1 and l2 replaced each other since pump shaft rotates counter-clockw ise.

Flange Dimensions



Suction Flange	Discharge Flange
AB = 150	AB = 100
Df = 285	Df = 220
k = 240	k = 180
n = 8	n = 8
s = 23	s = 19

" n " number of holes

Company		Date	15/02/2023
Project		Item	
		Ref No.	

SNDS 100-315-18.5

Horizontal, double suction, single stage, axially split volute casing pump

Motor Data

Efficiency Level :
 Motor type : Three-Phase Asynchronous Motor
 Motor Power : 18.5 kW
 Rated Speed : 1450 rpm
 Voltage : 400 V
 Rated Current : 0.00 A
 Frequency : 50 Hz
 Motor Phase : 3
 Service Factor : 1.15
 Insulation Class : F
 Degree of Protection : IP 55
 Efficiency : - %
 Power factor : 0.00