

Product description

MN25E80-160-2P-50-TM-SS

Pos.no	Description	Item no	Qty.	UP / €	TP / €
1	Close-coupled electric pump according to EN 733 (DIN 24255)				
2	Centrifugal pump: MN25E80-160-2P-50-TM-SS		1	Price on req.	Price on req.
3	<p>Pump bodies</p> <p>Close-coupled electric pumps in compliance with EN 733 - DIN 24255 standards coupled to IEC standard electric motors through rigid coupling.</p> <p>Duty point</p> <p>Flow : / Head :</p> <p>Pump operating data</p> <p>Impeller diameter : 161 mm / Speed : 2.900 1/min</p> <p>Flow : / Head :</p> <p>Shaft power P2 : / Efficiency :</p> <p>Head (Q = 0) : 34,35 m</p> <p>Pump body : Cast iron</p> <p>Impeller : Stainless steel</p> <p>Wear ring : Cast iron</p> <p>Support : Cast iron</p> <p>Coupling : Cast iron</p> <p>Shaft : Stainless steel</p> <p>Max. solid contents : 40 g/m³</p> <p>Max. water temperature : 90 °C</p> <p>Max. running time with Q=0 : 2 min</p>				
4	Motor: IEC 25 - 2		1		
5	<p>Electric motor</p> <p>Three-phase IE3 asynchronous squirrel cage motor.</p> <p>Casing : Cast iron</p> <p>Protection : IP 55</p> <p>Insulation class : F</p> <p>Number of startings : max 6</p> <p>Max environment temperature : 40 °C</p> <p>Max altimetric level : 1000 m</p> <p>Weight : 138 kg</p> <p>Frequency : 50 Hz</p> <p>N. poles : 2</p> <p>P2 : 18,5 kW</p> <p>U : 400 V</p> <p>In 1/1 : 32,5 A</p> <p>EFF : 92,4 %</p> <p>CosPhi : 0,89</p>				
6	Shaft seal: Mechanical seal		1		
7	<p>Cover : Cast iron</p> <p>Spacer : Stainless steel</p> <p>Seal face : Graphite</p> <p>Seat : Ceramic</p> <p>Seal ring : NBR</p> <p>Spring : AISI 304 stainless steel</p>				

Technical data

MN25E80-160-2P-50-TM-SS

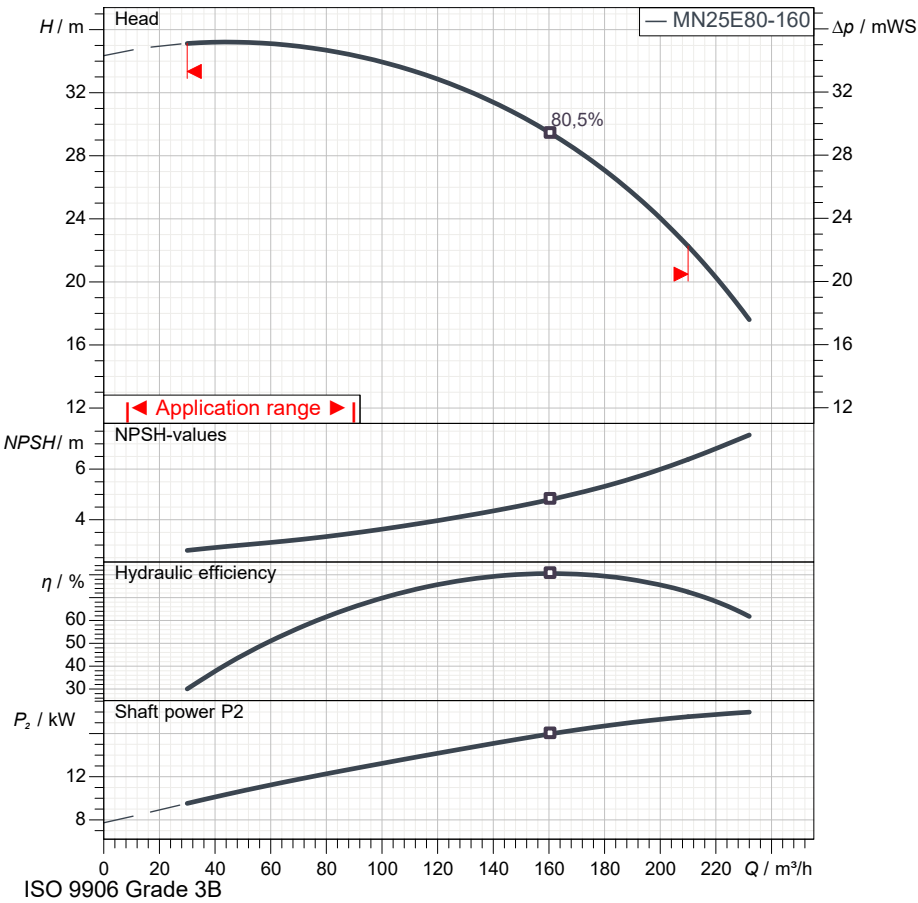

Operating data specification	
Capacity	
Head	
Fluid	Pure water
Type of installation	<Single head pump>

Pump operating data	
Design	MN25E80-160-2P-50-TM-SS
Impeller Ø	161 mm
Speed	2.900 1/min
Flow	
Head	
Shaft power P2	
Efficiency	
Head (Q=0)	34,4 m
Non return valve loss	

Electric motor technical data	
Design	IEC 25 - 2
Rated power	18,5 kW
Frequency	50 Hz
Number of poles	2
Nominal speed	2.900 1/min
Rated voltage	3~ 400 V
Starting mode	Direct starting
Rated current	32,5 A
Insulation class	F
Degree of protection	IP 55

Use limits	
Max N° startings/hour	6
Max. running time with Q=0	2 min
Max. solids contents	40 g/m³
Max. pumped liquid temperature	90 °C
Maximum density	998 kg/m³
Maximum viscosity	1 mm²/s

Materials	
Pump body	Cast iron
Impeller	Stainless steel
Wear ring	Cast iron
Support	Cast iron
Coupling	Cast iron
Shaft	Stainless steel

Shaft seal	
Cover	Cast iron
Spacer	Stainless steel
Seal face	Graphite
Seat	Ceramic
Seal ring	NBR
Spring	AISI 304 stainless steel

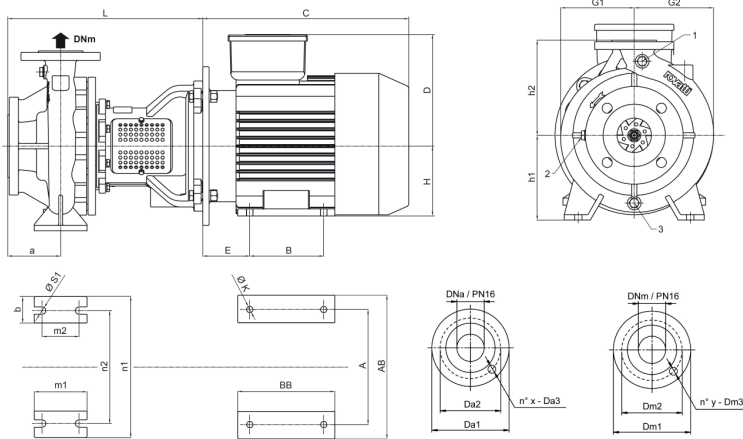

Dimensions in		mm		Total weight		192 kg	
a	125	Da1	220	E	108	m1	125
A	254	Da2	180	G1	144	m2	95
AB	315	Da3	18	G2	172	n1	320
b	65	Dm1	200	H	160	n2	250
B	254	Dm2	160	h1	180	s1	14
BB	305	Dm3	18	h2	225	x	8
C	543	DNa	100	K	15	y	8
D	250	DNrr	80	L	432		

Performance curves

MN25E80-160-2P-50-TM-SS

Performances				
Speed		2.900 1/min	Density	998 kg/m ³
Flow	Min.	30 m ³ /h	Viscosity	1 mm ² /s
	Max.	210 m ³ /h	Temperature	20 °C
Efficiency	Max.	161 m ³ /h	Tolerances	ISO 9906 Grade 3B

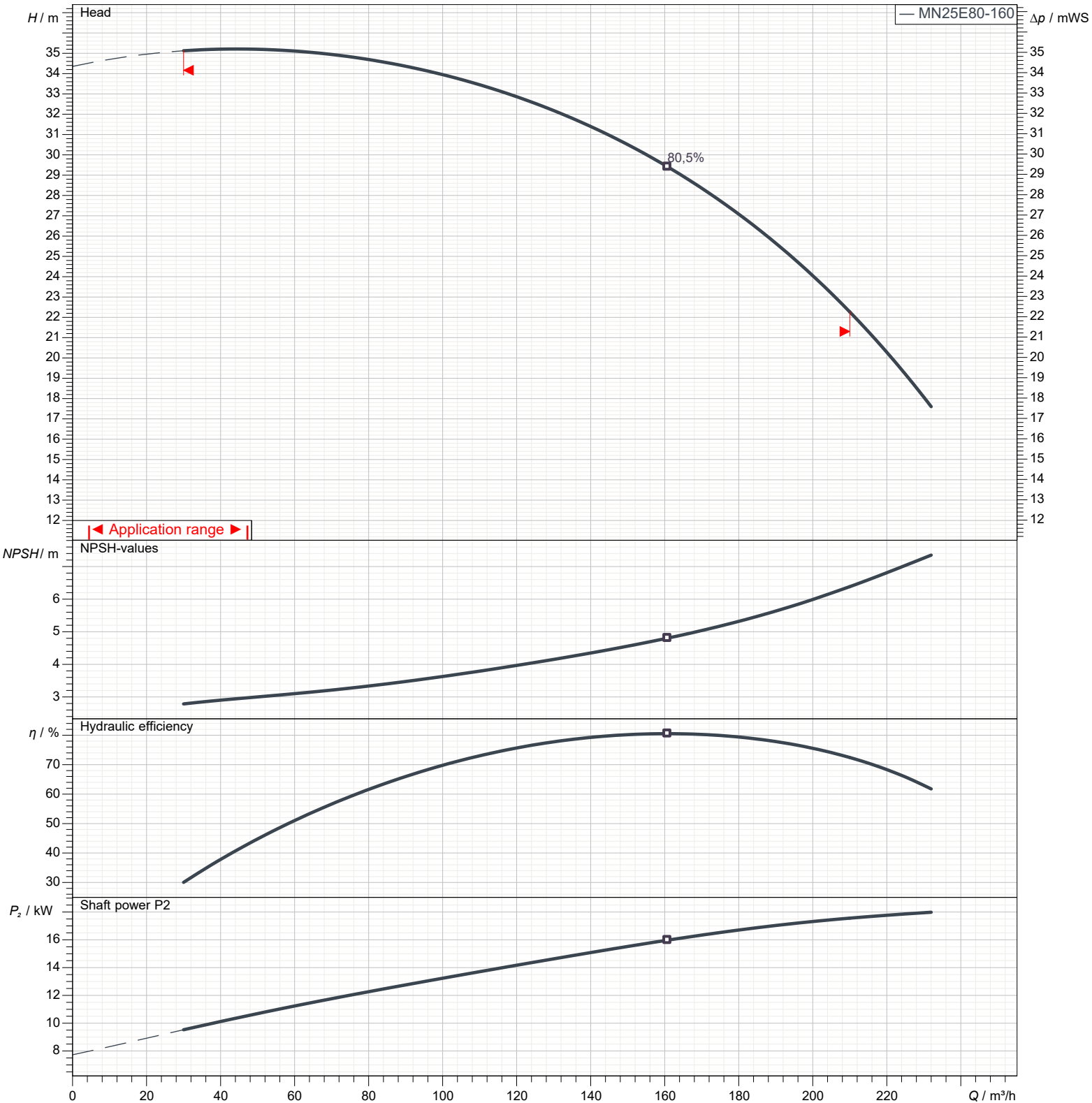

Types of installation

MN25E80-160-2P-50-TM-SS



Total weight		192 kg		Dimensions in mm	
a	125	h2	225		
A	254	K	15		
AB	315	L	432		
b	65	m1	125		
B	254	m2	95		
BB	305	n1	320		
C	543	n2	250		
D	250	s1	14		
Da1	220	x	8		
Da2	180	y	8		
Da3	18				
Dm1	200				
Dm2	160				
Dm3	18				
DNa	100				
DNm	80				
E	108				
G1	144				
G2	172				
H	160				
h1	180				