

Product description

MN15E40-200-2P-50-TM-SS

Pos.no	Description	Item no	Qty.	UP / €	TP / €
1	Close-coupled electric pump according to EN 733 (DIN 24255)				
2	Centrifugal pump: MN15E40-200-2P-50-TM-SS		1	Price on req.	Price on req.
3	<p>Pump bodies</p> <p>Close-coupled electric pumps in compliance with EN 733 - DIN 24255 standards coupled to IEC standard electric motors through rigid coupling.</p> <p>Duty point</p> <p>Flow : / Head :</p> <p>Pump operating data</p> <p>Impeller diameter : 199 mm / Speed : 2.900 1/min</p> <p>Flow : / Head :</p> <p>Shaft power P2 : / Efficiency :</p> <p>Head (Q = 0) : 55,58 m</p> <p>Pump body : Cast iron</p> <p>Impeller : Stainless steel</p> <p>Wear ring : Cast iron</p> <p>Support : Cast iron</p> <p>Coupling : Cast iron</p> <p>Shaft : Stainless steel</p> <p>Max. solid contents : 40 g/m³</p> <p>Max. water temperature : 90 °C</p> <p>Max. running time with Q=0 : 2 min</p>				
4	Motor: IEC 15 - 2		1		
5	<p>Electric motor</p> <p>Three-phase IE3 asynchronous squirrel cage motor.</p> <p>Casing : Cast iron</p> <p>Protection : IP 55</p> <p>Insulation class : F</p> <p>Number of startings : max 10</p> <p>Max environment temperature : 40 °C</p> <p>Max altimetric level : 1000 m</p> <p>Weight : 116 kg</p> <p>Frequency : 50 Hz</p> <p>N. poles : 2</p> <p>P2 : 11 kW</p> <p>U : 400 V</p> <p>In 1/1 : 19,3 A</p> <p>EFF : 91,2 %</p> <p>CosPhi : 0,9</p>				
6	Shaft seal: Mechanical seal		1		
7	<p>Cover : Cast iron</p> <p>Spacer : Stainless steel</p> <p>Seal face : Graphite</p> <p>Seat : Ceramic</p> <p>Seal ring : NBR</p> <p>Spring : AISI 304 stainless steel</p>				

Technical data

MN15E40-200-2P-50-TM-SS

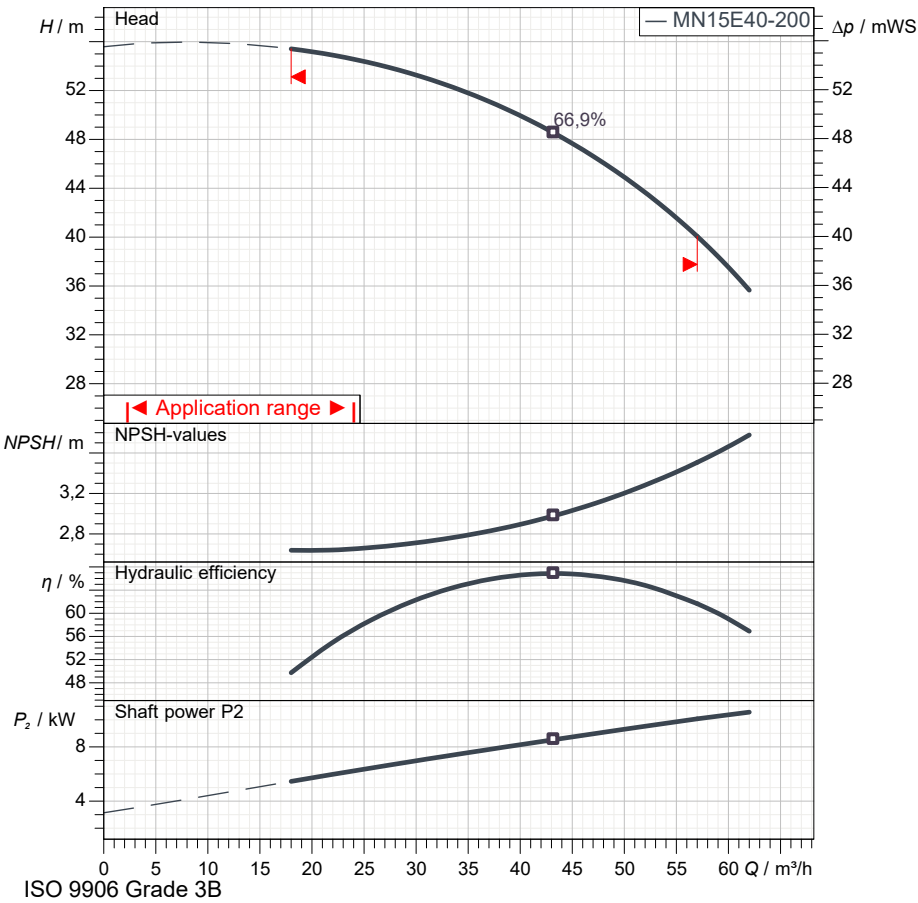

Operating data specification	
Capacity	
Head	
Fluid	Pure water
Type of installation	<Single head pump>

Pump operating data	
Design	MN15E40-200-2P-50-TM-SS
Impeller Ø	199 mm
Speed	2.900 1/min
Flow	
Head	
Shaft power P2	
Efficiency	
Head (Q=0)	55,6 m
Non return valve loss	

Electric motor technical data	
Design	IEC 15 - 2
Rated power	11 kW
Frequency	50 Hz
Number of poles	2
Nominal speed	2.900 1/min
Rated voltage	3~ 400 V
Starting mode	Direct starting
Rated current	19,3 A
Insulation class	F
Degree of protection	IP 55

Use limits	
Max N° startings/hour	10
Max. running time with Q=0	2 min
Max. solids contents	40 g/m³
Max. pumped liquid temperature	90 °C
Maximum density	998 kg/m³
Maximum viscosity	1 mm²/s

Materials	
Pump body	Cast iron
Impeller	Stainless steel
Wear ring	Cast iron
Support	Cast iron
Coupling	Cast iron
Shaft	Stainless steel

Shaft seal	
Cover	Cast iron
Spacer	Stainless steel
Seal face	Graphite
Seat	Ceramic
Seal ring	NBR
Spring	AISI 304 stainless steel

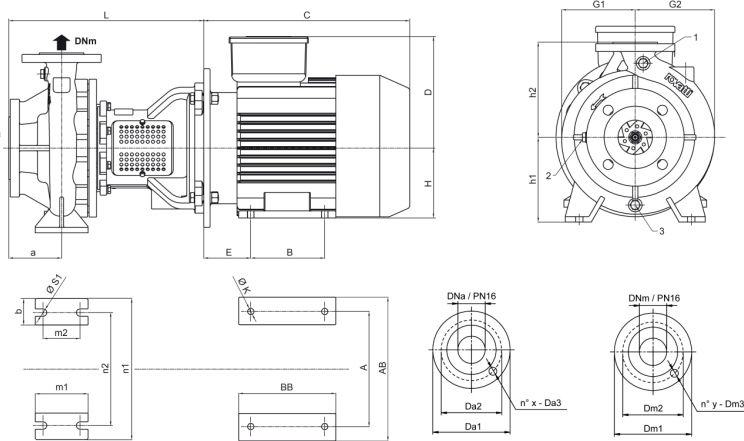

Dimensions in mm				Total weight				167 kg
a	100	Da1	185	E	108	m1	100	
A	254	Da2	145	G1	140	m2	70	
AB	315	Da3	18	G2	150	n1	265	
b	50	Dm1	150	H	160	n2	212	
B	210	Dm2	110	h1	160	s1	14	
BB	260	Dm3	18	h2	180	x	4	
C	510	DNa	65	K	15	y	4	
D	250	DNrr	40	L	407			

Performance curves

MN15E40-200-2P-50-TM-SS

Performances				
Speed		2.900 1/min	Density	998 kg/m ³
Flow	Min.	18 m ³ /h	Viscosity	1 mm ² /s
	Max.	57 m ³ /h	Temperature	20 °C
Efficiency	Max.	43,2 m ³ /h	Tolerances	ISO 9906 Grade 3B

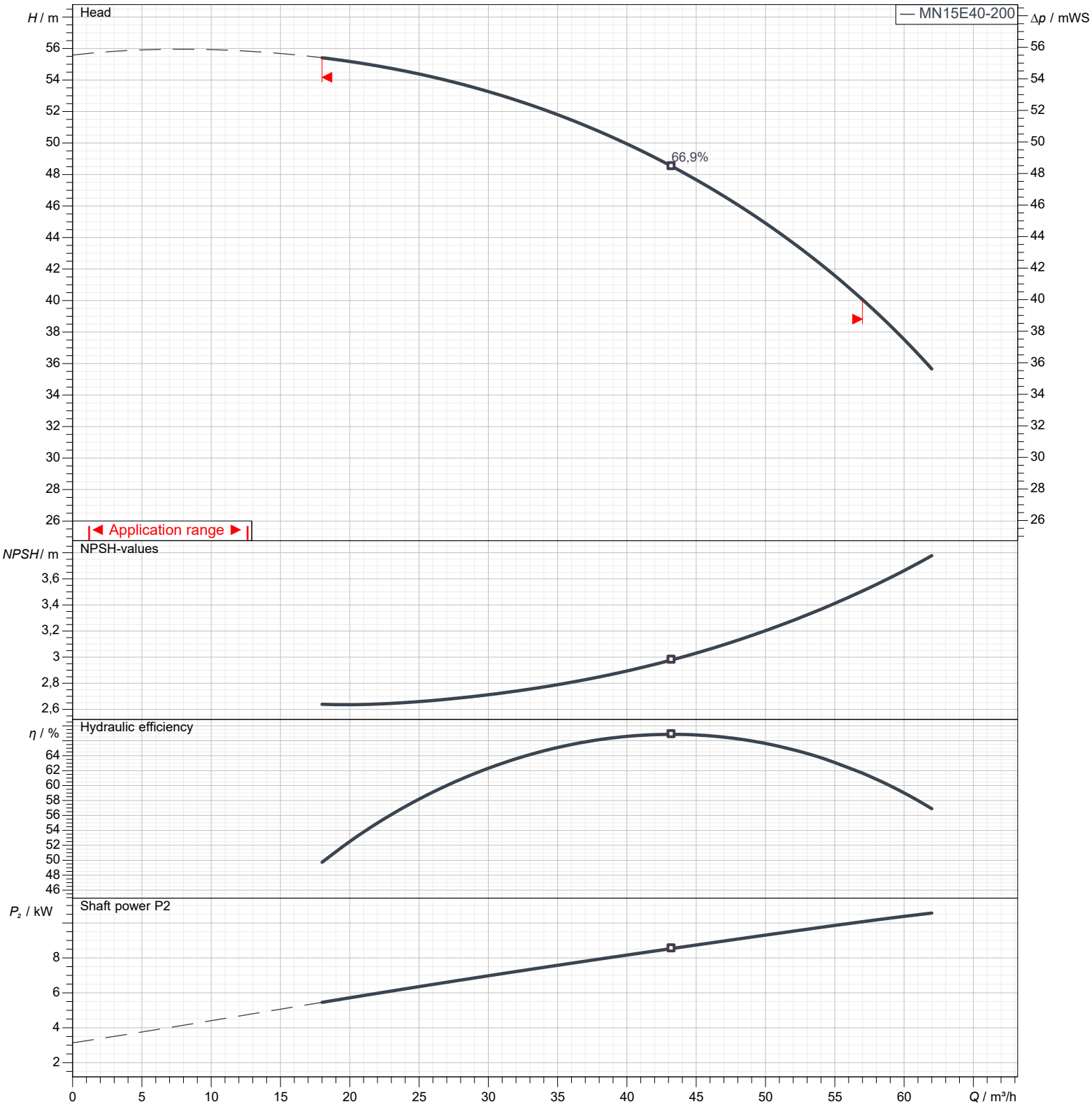

Types of installation

MN15E40-200-2P-50-TM-SS



Total weight		167 kg		Dimensions in mm	
a	100	h2	180		
A	254	K	15		
AB	315	L	407		
b	50	m1	100		
B	210	m2	70		
BB	260	n1	265		
C	510	n2	212		
D	250	s1	14		
Da1	185	x	4		
Da2	145	y	4		
Da3	18				
Dm1	150				
Dm2	110				
Dm3	18				
DNa	65				
DNm	40				
E	108				
G1	140				
G2	150				
H	160				
h1	160				